

A

SECTION EX

EX

C

D

E

F

G

H

I

J

K

L

M

N

O

P

EXHAUST SYSTEM

CONTENTS

PRECAUTION	2	REMOVAL AND INSTALLATION	5	
PRECAUTIONS	2	EXHAUST SYSTEM	5	
Removal and Installation	2	VQ37VHR	5	
PREPARATION	3	VQ37VHR : Exploded View	5	
PREPARATION	3	VQ37VHR : Removal and Installation	6	
Special Service Tool	3	VQ37VHR : Inspection	6	
Commercial Service Tool	3	VK56VD	6	
PERIODIC MAINTENANCE	4	VK56VD : Exploded View	7	
EXHAUST SYSTEM	4	VK56VD : Removal and Installation	7	
Inspection	4	VK56VD : Inspection	8	

PRECAUTIONS

< PRECAUTION >

PRECAUTION

PRECAUTIONS

Removal and Installation

INFOID:000000005984944

CAUTION:

- Be sure to use genuine exhaust system parts or equivalents which are specially designed for heat resistance, corrosion resistance, and shape.
- Perform the operation with the exhaust system fully cooled down because the system will be hot just after engine stops.
- Be careful not to cut your hand on the heat insulator edge.

PREPARATION

< PREPARATION >

PREPARATION

PREPARATION

Special Service Tool

INFOID:000000005984945

A

EX

The actual shapes of Kent-Moore tools may differ from those of special service tools illustrated here.

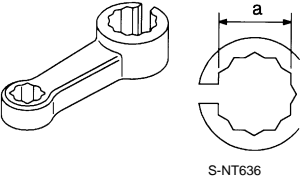
Tool number (Kent-Moore No.) Tool name	Description
KV10114400 (J-38365) Heated oxygen sensor wrench 	Loosening or tightening heated oxygen sensor 2 For 22 mm (0.87 in) (a) width hexagon nut



C

D

E

Commercial Service Tool

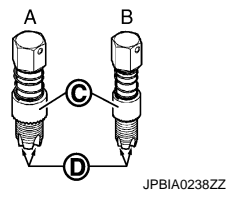
INFOID:000000005984946

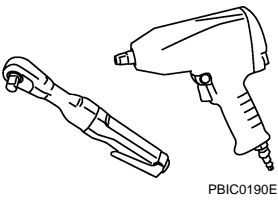
(Kent-Moore No.) Tool name	Description
A: (J-43897-18) B: (J-43897-12) Heated oxygen sensor thread cleaner 	Reconditioning the exhaust system threads before installing a new heated oxygen sensor (Use with anti-seize lubricant shown below.) A: J-43897-18 [18 mm (0.71 in) dia.] for zirconia heated oxygen sensor B: J-43897-12 [12 mm (0.47 in) dia.] for titania heated oxygen sensor C: Mating surface shave cylinder D: Flutes
(—) Anti-seize lubricant (Permatex 133AR or equivalent meeting MIL specification MIL-A-907) 	Lubricating heated oxygen sensor thread cleaner when reconditioning exhaust system threads
(—) Power tool 	Loosening bolts and nuts

F

G

H

I

J

K

L

M

N

O

P

EXHAUST SYSTEM

< PERIODIC MAINTENANCE >

PERIODIC MAINTENANCE

EXHAUST SYSTEM

Inspection

INFOID:000000005984947

Check exhaust pipes, muffler and mounting for improper attachment, leaks, cracks, damage or deterioration.

- If anything is found, repair or replace damaged parts.

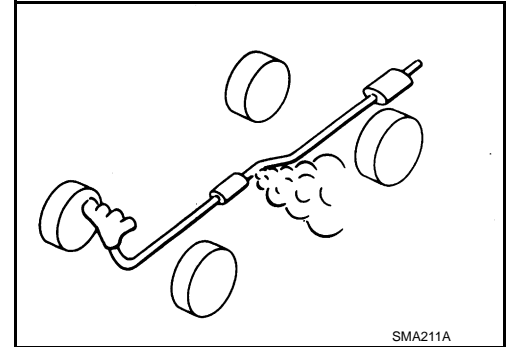

EXHAUST SYSTEM

< REMOVAL AND INSTALLATION >

REMOVAL AND INSTALLATION

EXHAUST SYSTEM

VQ37VHR

VQ37VHR : Exploded View

INFOID:000000005984948

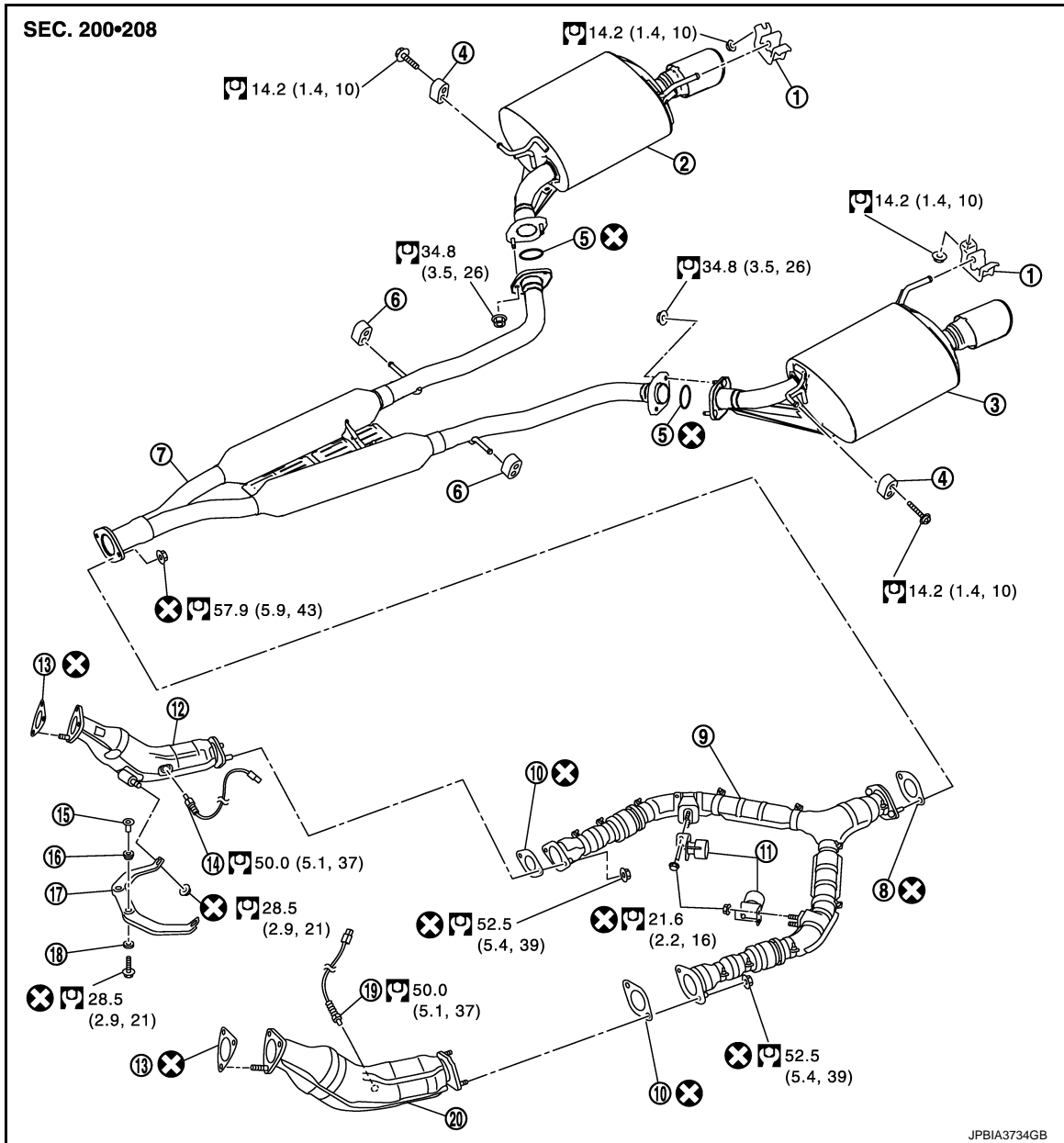

- | | | |
|-------------------------------------|-------------------------------------|---------------------------------|
| 1. Mounting rubber | 2. Main muffler (RH) | 3. Main muffler (LH) |
| 4. Mounting rubber | 5. Ring gasket | 6. Mounting rubber |
| 7. Center muffler | 8. Gasket | 9. Exhaust front tube |
| 10. Gasket | 11. Dynamic damper | 12. Three way catalyst (bank 1) |
| 13. Gasket | 14. Heated oxygen sensor 2 (bank 1) | 15. Collar |
| 16. Grommet | 17. Exhaust mounting bracket | 18. Grommet |
| 19. Heated oxygen sensor 2 (bank 2) | 20. Three way catalyst (bank 2) | |

Refer to [GI-4, "Components"](#) for symbols in the figure.

EXHAUST SYSTEM

< REMOVAL AND INSTALLATION >

VQ37VHR : Removal and Installation

INFOID:000000005984949

REMOVAL

- Disconnect each joint and mounting using power tool.
- Remove heated oxygen sensor 2 as follows:
 - Using heated oxygen sensor wrench [SST: KV10114400 (J-38365)] (C), removal heated oxygen sensor 2.

A : Bnak 1

B : Bnak 2

⇐ : Vehicle front

CAUTION:

Be careful not to damage heated oxygen sensor 2.

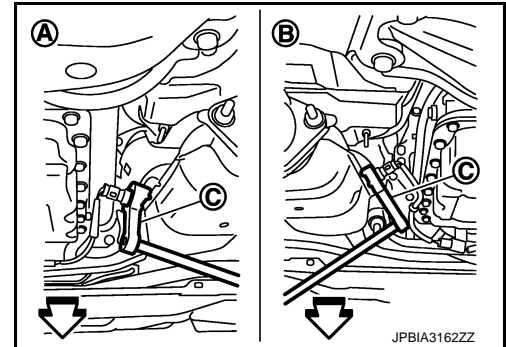

INSTALLATION

Note the following, and install in the reverse order of removal.

- Check for deformation of the grommets (16 and 18 of Components).
- Insert the collar (15 of Components) vertically.
- Temporarily tighten nuts and bolts when installing exhaust pipe assembly. Tighten them to the specified torque when connecting the vehicle rear to the vehicle front.

CAUTION:

- Always replace exhaust tube gaskets with new ones when reassembling.
- Discard any heated oxygen sensor 2 which has been dropped onto a hard surface such as a concrete floor. Use a new one.
- Before installing a new heated oxygen sensor 2, clean exhaust system threads using the heated oxygen sensor thread cleaner (commercial service tool: J-43897-18 or J-43897-1), and apply the anti-seize lubricant (commercial service tool).
- Never over torque heated oxygen sensor 2. Doing so may cause damage to heated oxygen sensor 2, resulting in the "MIL" coming on.
- If heat insulator is badly deformed, repair or replace it. If deposits such as mud pile up on the heat insulator, remove them.
- When installing heat insulator avoid large gaps or interference between heat insulator and each exhaust pipe.
- Remove deposits from the sealing surface of each connection. Connect them securely to avoid gases leakage.
- Temporarily tighten mounting nuts on the exhaust manifold side and mounting bolts on the vehicle side. Check each part for unusual interference, and then tighten them to the specified torque.
- When installing each mounting rubber, avoid twisting or unusual extension in up/down and right/left directions.

VQ37VHR : Inspection

INFOID:000000005984950

INSPECTION AFTER INSTALLATION

- Check clearance between tail tube and rear bumper is even.
- With engine running, check exhaust tube joints for gas leakage and unusual noises.
- Check to ensure that mounting brackets and mounting rubbers are installed properly and free from undue stress. Improper installation could result in excessive noise and vibration.

VK56VD

EXHAUST SYSTEM

< REMOVAL AND INSTALLATION >

VK56VD : Exploded View

INFOID:000000006037407

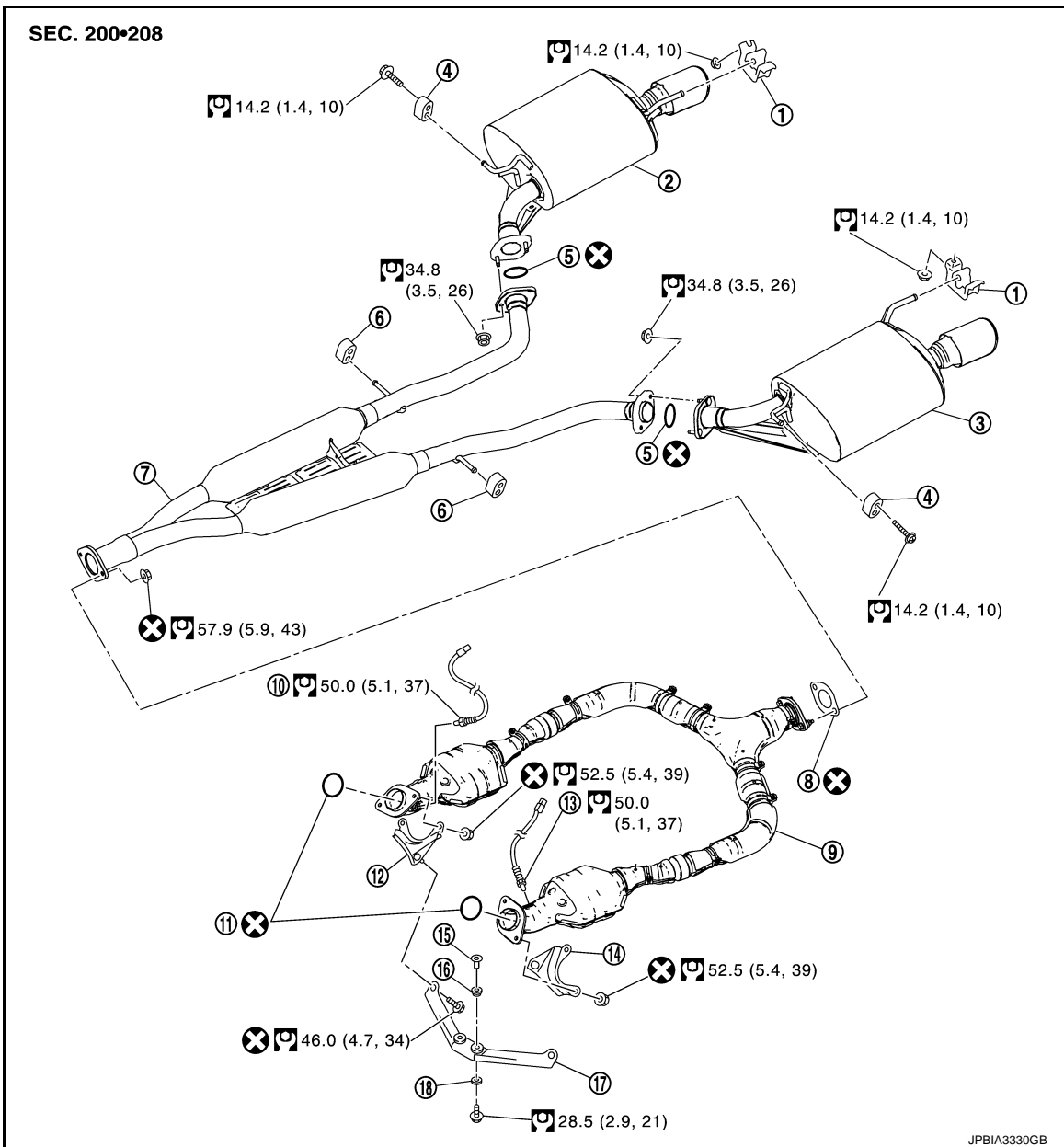

- | | | |
|-------------------------------------|----------------------|-----------------------|
| 1. Mounting rubber | 2. Main muffler (RH) | 3. Main muffler (LH) |
| 4. Mounting rubber | 5. Ring gasket | 6. Mounting rubber |
| 7. Center muffler | 8. Gasket | 9. Exhaust front tube |
| 10. Heated oxygen sensor 2 (bank 2) | 11. Ring gasket | 12. Mounting bracket |
| 13. Heated oxygen sensor 2 (bank 1) | 14. Mounting bracket | 15. Collar |
| 16. Grommet | 17. Mounting bracket | 18. Grommet |

Refer to [GI-4, "Components"](#) for symbols in the figure.

VK56VD : Removal and Installation

INFOID:000000006037908

REMOVAL

- Disconnect each joint and mounting using power tool.
- Remove heated oxygen sensor 2 as follows:

EXHAUST SYSTEM

< REMOVAL AND INSTALLATION >

- Using heated oxygen sensor wrench [SST: KV10114400 (J-38365)] (C), removal heated oxygen sensor 2.

A : Bnak 2

B : Bnak 1

↔ : Vehicle front

CAUTION:

Be careful not to damage heated oxygen sensor 2.

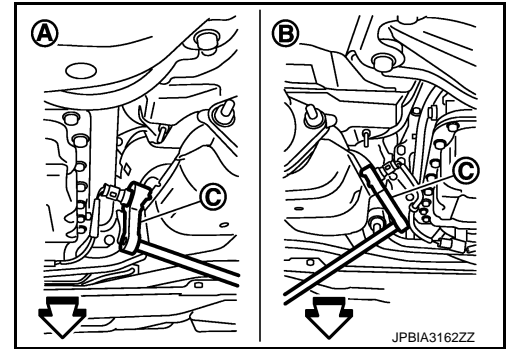

INSTALLATION

Note the following, and install in the reverse order of removal.

- Check for deformation of the grommets (20 and 22 of Components).
- Insert the collar (19 of Components) vertically.
- Install the collar (5 of Components) with its lower surface horizontal.
- Temporarily tighten nuts and bolts when installing exhaust pipe assembly. Tighten them to the specified torque when connecting the vehicle rear to the vehicle front.

CAUTION:

- Always replace exhaust tube gaskets with new ones when reassembling.
- Discard any heated oxygen sensor 2 which has been dropped onto a hard surface such as a concrete floor. Use a new one.
- Before installing a new heated oxygen sensor 2, clean exhaust system threads using the heated oxygen sensor thread cleaner (commercial service tool: J-43897-18 or J-43897-1), and apply the anti-seize lubricant (commercial service tool).
- Never over torque heated oxygen sensor 2. Doing so may cause damage to heated oxygen sensor 2, resulting in the "MIL" coming on.
- If heat insulator is badly deformed, repair or replace it. If deposits such as mud pile up on the heat insulator, remove them.
- When installing heat insulator avoid large gaps or interference between heat insulator and each exhaust pipe.
- Remove deposits from the sealing surface of each connection. Connect them securely to avoid gases leakage.
- Temporarily tighten mounting nuts on the exhaust manifold side and mounting bolts on the vehicle side. Check each part for unusual interference, and then tighten them to the specified torque.
- When installing each mounting rubber, avoid twisting or unusual extension in up/down and right/left directions.

VK56VD : Inspection

INFOID:000000006037409

INSPECTION AFTER INSTALLATION

- Check clearance between tail tube and rear bumper is even.
- With engine running, check exhaust tube joints for gas leakage and unusual noises.
- Check to ensure that mounting brackets and mounting rubbers are installed properly and free from undue stress. Improper installation could result in excessive noise and vibration.